

MULTI-FUNCTION MICROPHONE WITH DTMF

# MC-57DM/58DM

## SERVICE MANUAL

# KENWOOD

© 2002-2 PRINTED IN JAPAN  
B51-8625-00 (S) 789

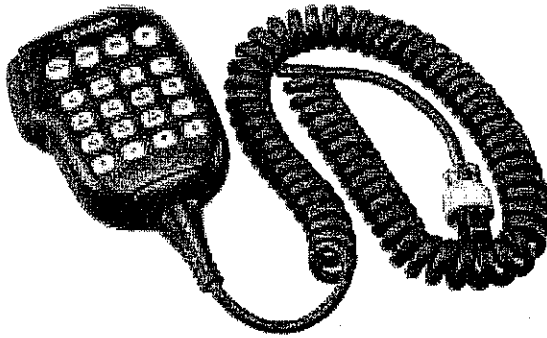

MC-57DM

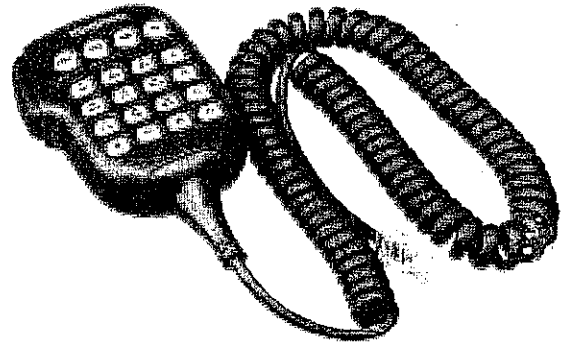

MC-58DM

## SPECIFICATIONS

Type	Electret capacitor
Power requirement	8.0 V DC $\pm 10\%$
Current drain	35 mA or less
Dimensions (WxHxD)	65 x 90 x 30 mm 2 9/16 x 3 17/32 x 1 3/16 inches
Weight	Approx. 180 g/ 6.3 oz
Sensitivity	-52 $\pm 3$ dB (at 1 kHz) (0 dB = 1 V/Pa)

# MC-57DM/58DM

## SCHEMATIC DIAGRAM

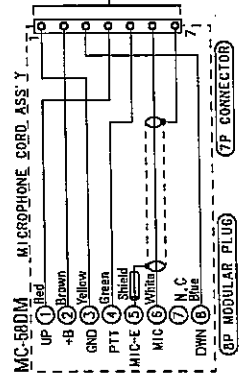
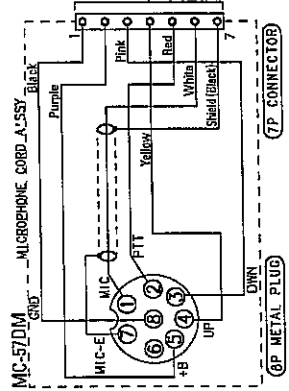
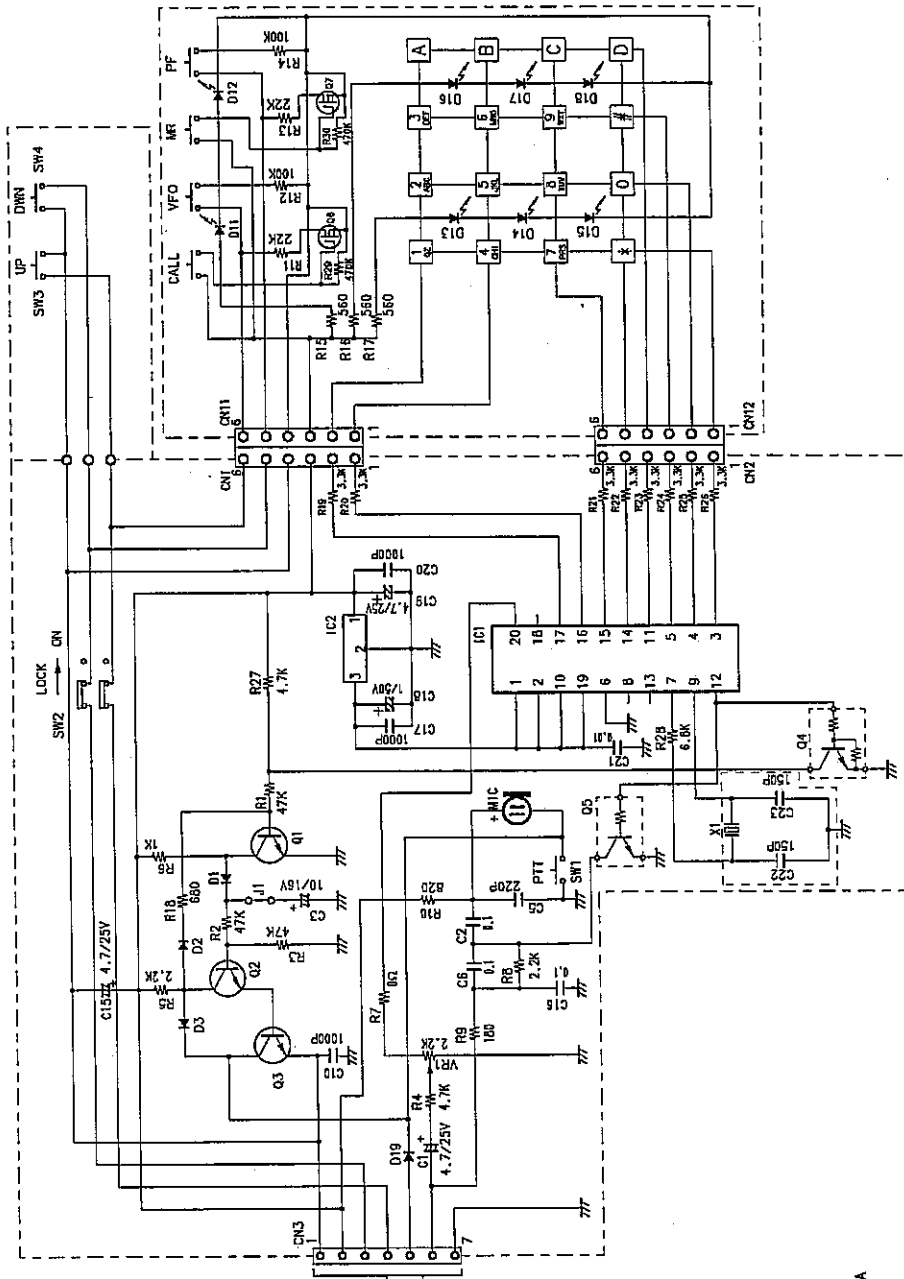

- Q1-Q3 : TRANSISTOR
- D1 : DIODE
- D2, D3 : DIODE
- IC1 : IC
- IC2 : IC
- X1 : CERAMIC RESONATOR (480KHz)
- VR1 : TRIMMER POTENTIOMETER
- D19 : DIODE
- Q5 : TRANSISTOR
- Q6, Q7 : MOS FET
- D11-D18 : LED
- 2SC1623
- DTC144EKA
- DAN212K
- MA2BW-A
- TC5218F
- TA7BL05F
- CSB480E14
- RI:041IC222
- RB451F
- DTC144TKA
- 2SK1824
- SNL-210DT

# MC-57DM/58DM

## CONNECTOR END VIEW

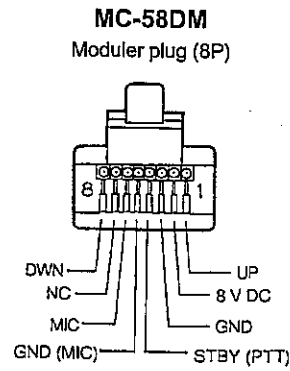
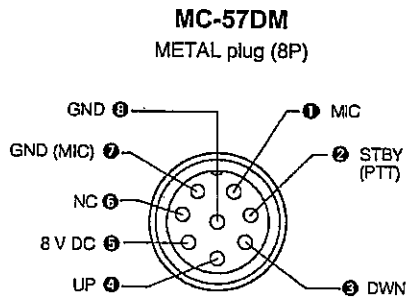

## ADJUSTMENT

Item	Condition	Test equipment/Measurement	Adjustment	Specifications/Remarks
DTMF output level	3 6 key at same time push		VR1	2.4mV ±0.01mV

\* When you change the R10 from 820Ω to 1.8kΩ, the microphone sensitivity increases approximately 6dB.

# MC-57DM/58DM

## PARTS LIST

MC-57DM/58DM (Y58-3490-21/Y58-3500-21)

\* New Parts.

Ref. No.	Address	New parts	Parts No.	Description	Destination
		*	A02-3760-08	CABINET(FRONT)	
		*	A02-3761-08	CABINET(REAR)	
		*	862-1660-00	INSTRUCTION MANUAL	
			E30-3243-08	CURL CABLE(8P METAL)	57DM
			E30-3240-08	CURL CABLE(8P MODULER)	58DM
			J29-0630-08	HOOK	
		*	K29-9225-08	KNOB ASSY(PTT)	
			K29-5102-08	KNOB(UP,DOWN)	
		*	K29-5439-08	KEY TOP(20KEY)	
			K29-5104-08	KNOB(LOCK)	
			N53-3020-41	FLAT HEAD TAPPING SCREW(HOOK)	
SW3,4			S40-1117-05	TACT SWITCH(UP,DOWN)	
SW2			S62-0441-08	SLIDE SWITCH(LOCK)	
SW1			S70-0465-08	TACT SWITCH(PTT)	
			T91-0570-08	MIC ELEMENT	

## KENWOOD CORPORATION

14-6, Dogenzaka 1-chome, Shibuya-ku, Tokyo 150-8501, Japan

### KENWOOD SERVICE CORPORATION

P.O. BOX 22745, 2201 East Dominguez Street, Long Beach, CA 90801-5745, U.S.A.

### KENWOOD ELECTRONICS CANADA INC.

6070 Kestrel Road, Mississauga, Ontario, Canada L5T 1S8

### KENWOOD ELECTRONICS DEUTSCHLAND GMBH

Rembrücker Str. 15, 63150 Heusenstamm, Germany

### KENWOOD ELECTRONICS BELGIUM N.V.

Leuvensesteenweg 248 J, 1800 Vilvoorde, Belgium

### KENWOOD ELECTRONICS FRANCE S.A.

13, Boulevard Ney, 75018 Paris, France

### KENWOOD ELECTRONICS U.K. LIMITED

KENWOOD House, Dwight Road, Watford, Herts., WD1 8EB United Kingdom

### KENWOOD ELECTRONICS EUROPE B.V.

Amsterdamseweg 37, 1422 AC Uithoorn, The Netherlands

### KENWOOD ELECTRONICS ITALIA S.p.A.

Via G. Sirtori, 7/9 20129 Milano, Italy

### KENWOOD IBERICA S.A.

Bolivia, 239-08020 Barcelona, Spain

### KENWOOD ELECTRONICS AUSTRALIA PTY. LTD.

(A.C.N. 001 499 074)

16 Giffnock Avenue, Centrecourt Estate, North Ryde, N.S.W. 2113, Australia

### KENWOOD ELECTRONICS (HONG KONG) LTD.

Unit 3712-3724, Level 37, Tower one Metroplaza, 223 Hing Fong Road, Kwai Fong, N.T., Hong Kong

### KENWOOD ELECTRONICS TECHNOLOGIES(S) PTE LTD.

Sales Marketing Division

1 Ang Mo Kio Street 63, Singapore 569110

